

Product Selection

Type	Actuator Type	Trapped Key Condition	Cat. No.
Single key	Standard	Key trapped to release actuator	440T-MSSLE10*
	Flexible		440T-MSSLE11*
	Flat		440T-MSSLE12*
Dual key	Standard	Primary key trapped, secondary key free to release actuator	440T-MDSLE10*⊗
	Flexible		440T-MDSLE11*⊗
	Flat		440T-MDSLE12*⊗
	Standard	Both keys trapped to release actuator	440T-MDSLE20**
	Flexible		440T-MDSLE22**
	Flat		440T-MDSLE23**
Dual with secondary ejector key	Standard	Primary key trapped, secondary key free to release actuator	440T-MDSLJ10*⊗
	Flexible		440T-MDSLJ11*⊗
	Flat		440T-MDSLJ12*⊗

\* Substitute the desired primary code for this symbol (key not included). See 3-107 for code selection.  
 ⊗ Substitute the desired secondary code for this symbol (key included). See 3-107 for code selection.

Accessories

Description	Additional Information	Cat. No.
Stainless steel key	3-140	440T-AKEYE10⊗
Stainless steel ejector key		440T-AKEYE13⊗
Stainless steel replacement code barrel with dust cap		440T-ASCBE14*
Stainless steel weatherproof replacement dust cap		440T-ASFC10⊗
GD2 standard actuator	—	440G-A27011
GD2 flat actuator	—	440K-A11112
Fully flex actuator	—	440G-A27143

\* Substitute the desired primary code for this symbol (key not included). See 3-107 for code selection.  
 ⊗ Substitute the desired code for this symbol. See 3-107 for code selection.

Approximate Dimensions [mm (in.)]

Dimensions are not intended to be used for installation purposes.

Single Key Slamlock

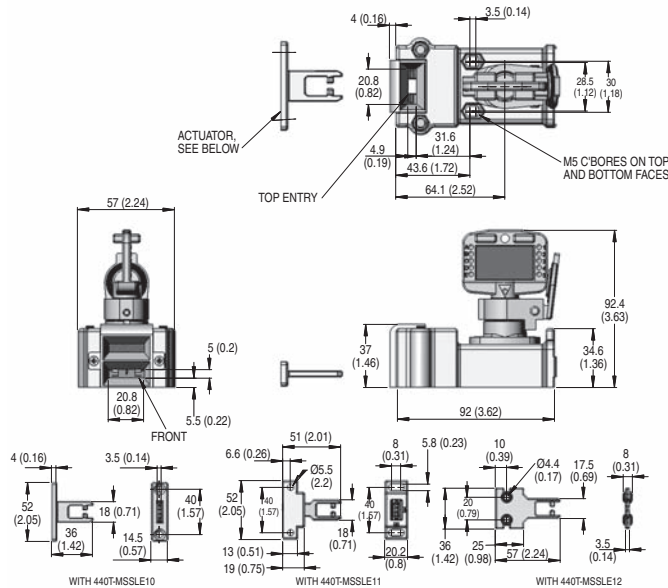

Dual Key Slamlock

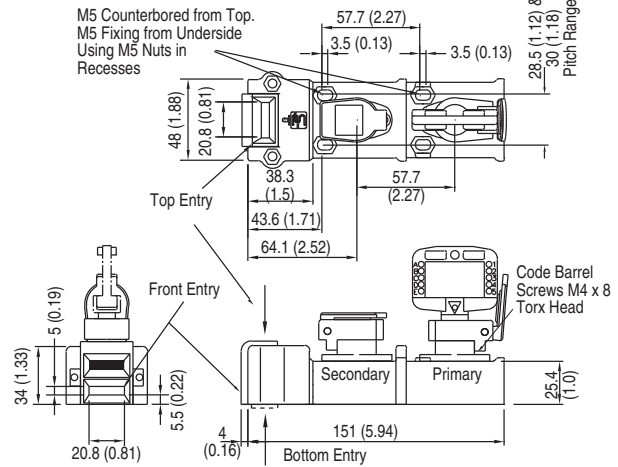

Flat Actuator

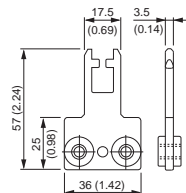

Flexible/Adjustable Actuator

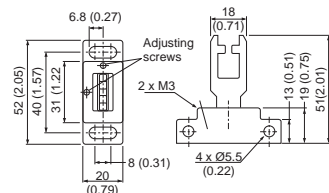

Standard Actuator

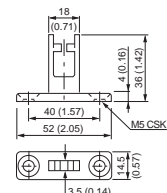

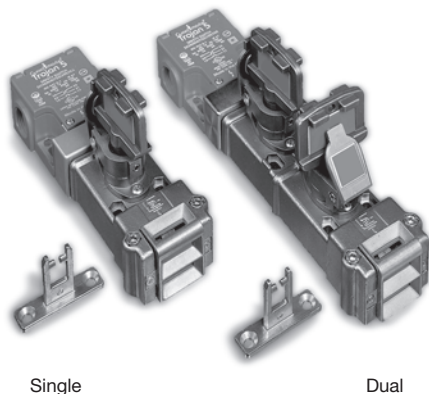

### Description

The Prosafe Slamlock with electrical isolation combines the features of trapped key tongue actuated interlocks while also providing sets of electrical safety and auxiliary contacts. When the actuator is inserted into the lock and the key is removed the actuator is trapped in the unit thus locking closed the guard door. In this state the safety contacts are closed and the auxiliary contacts are open. To open the guard door the key must be inserted and rotated 90°, opening the safety contacts, closing the auxiliary contacts and enabling the actuator to be released thus unlocking the guard door. While the guard door is open the key is trapped in the unit.

Slamlocks with electrical isolation offer the features of electrical safety interlock switches with the benefits of a trapped key/enforced sequence systems. They allow a combination of both approaches for safeguarding machinery and processes to be used.

The Single-key Slamlock (SSS) is used to interlock hatches, guards and doors where full body access is not required. The single key locks the actuator and operates the switch in the same action.

Dual-key Slamlock (DSS) is similar to the single key version but has a secondary key to allow "two key in" or "key exchange" conditions. The key exchange version may be used where whole body access is required, as the secondary key can be used as a personnel key.

### Features

- Electrical safety contacts combined with trapped key/enforced sequence feature
- Most of unit constructed from 316L stainless steel
- Selection of actuator types available
- Single or dual key versions available
- Direct drive operation
- Replaceable code barrel assembly
- Weatherproof stainless steel dust cap as standard
- Solenoid versions

### The Prosafe Advantage

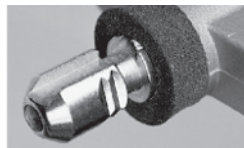

Stainless steel construction.

### Specifications

#### Safety Ratings

Standards	EN1088, IEC/EN60947-5-1, GS-ET-19, ISO12100-1&2, ISO14119, AS4024.1
Category	Cat. 1 per EN 954-1 (ISO 13849-1) Suitable for Cat. 2, 3, or 4 systems
Certifications	CE Marked for all applicable directives and BG; C-Tick not required

#### Outputs

Safety Contacts	2 N.C. positive break
Switching Current @ Voltage, Max.	500V/500V A
Thermal Current (Ith)	10 A
Current, Min.	5 mA @ 5V DC
Safety Contact Gap	>2 x 2 mm (0.07 in.)
Rated Insulation Voltage	(Ui) 500V
Rated Impulse withstand Voltage	(Uimp) 2500V
Auxiliary Contacts	1 N.O.

#### Operating Characteristics

Break Contact Force, Min.	12 N (2.7 lbs)
Actuation Speed, Max.	1 ms
Actuation Frequency, Max.	2 cycle/s

#### Utilization Category

AC 15	(Ue)	500V	250V	100V
	(Ie)	1 A	2 A	5 A
DC		250V	0.5 A, 24V	2 A

#### Environmental Characteristics

Enclosure Type Rating	IP67
Operating Temperature [C (F)]	Electrical: -20...+80 ° (-4...+176°) Solenoid: -20...+60 ° (-4...+140 °)
Relative Humidity	95%

#### Physical Characteristics

Actuator Travel for Positive Opening	5 mm (0.19 in.)
Operating Radius, Min.	175 mm (6.88 in.) [60 mm (2.36 in.) with flexible actuator]
Actuator Holding Force, Max.	2000 N (450 lbs)
Releasable Load, Max.	100 N (22.5 lbs)
Case Material	UL Approved glass-filled polyester & 316L stainless steel
Actuator Material	Stainless steel
Conduit Entry	3 x M20
Mounting	SSS: 4 x M5 counterbored from top or 4 x M5 from underside with nuts DSS: 6 x M5 counterbored from top or 6 x M5 from underside with nuts
Mechanical Life	100,000 operations
Electrical Life	1,000,000 operations
Weight [g (lbs)]	SSE: 1160 (2.6) DSSE: 1700 (3.7)
Color	Red/Stainless
Shear Force to Key	15.1 k•N (3398 lbs), max.
Pollution Degree	3
Torque to Key	14 N•m (124 lb•in), max.

**Note:** The safety contacts of the Guardmaster switches are described as normally closed (N.C.), i.e. with the guard closed, actuator in place (where relevant) and the machine able to be started.

Product Selection - Electrical

Contact Type	Type	Trapped Key Condition	Actuator Type	Cat. No.
2 N.C. + 1 N.O. Break before make	Single key	Key trapped to release actuator	Standard	440T-MSSSE10*
			Flexible	440T-MSSSE11*
			Flat	440T-MSSSE12*
		Key free to release actuator	Standard	440T-MSSSE20*
			Flexible	440T-MSSSE22*
			Flat	440T-MSSSE23*
	Dual key	Primary key trapped, secondary key free to release actuator	Standard	440T-MDSSE10*⊗
				440T-MDSSJ10*⊗
		Primary key trapped, secondary key eject to release actuator	Flexible	440T-MDSSE11*⊗
				440T-MDSSJ11*⊗
		Primary key trapped, secondary key free to release actuator	Flat	440T-MDSSE12*⊗
				440T-MDSSJ12*⊗
Both keys free to release actuator	Standard	440T-MDSSE20**		
	Flexible	440T-MDSSE22**		
	Flat	440T-MDSSE23**		
2 N.C. + 2 N.O. Break before make	Single key	Key free to release actuator	Standard	440T-MSSSE26*
			Flexible	440T-MSSSE27*
			Flat	440T-MSSSE25*

\* Substitute the desired primary code for this symbol (key not included). See 3-107 for code selection.  
 ⊗ Substitute the desired secondary code for this symbol (key included). See 3-107 for code selection.

Product Selection - Solenoid

Contact Type	Type	Trapped Key Condition	Solenoid Voltage	Actuator Type	Cat. No.
2 N.C. & 1 N.O. Break before make	Single key	Key free to release actuator	24V DC	Standard	440T-MSSUE20*
				Flexible	440T-MSSUE22*
				Flat	440T-MSSUE23*
	Dual key	Primary key trapped, secondary key free to release actuator	24V DC	Standard	440T-MDSUE10*
				Flexible	440T-MDSUE11*
				Flat	440T-MSSUE12*
Single key	Key free to release actuator	110V AC	Standard	440T-MSSUE50*	

\* Substitute the desired primary code for this symbol (key not included). See 3-107 for code selection.

Approximate Dimensions [mm (in.)]

Dimensions are not intended to be used for installation purposes.

Single Key Slamlock

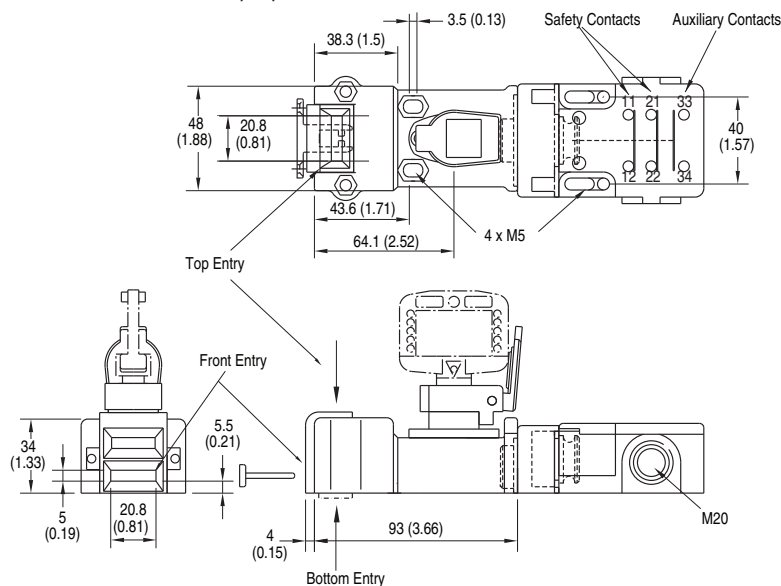

3-Trapped Key  
Switches

Approximate Dimensions [mm (in.)] (continued)





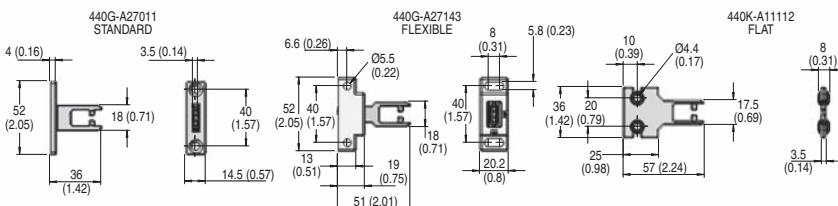
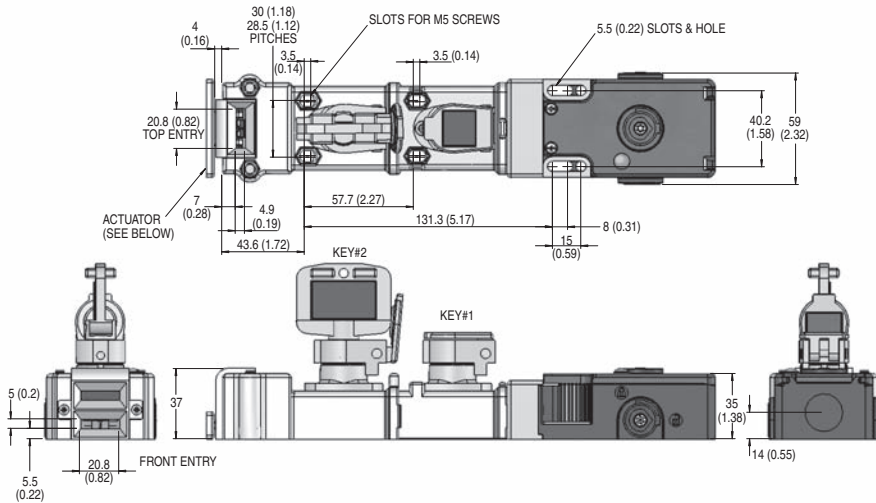
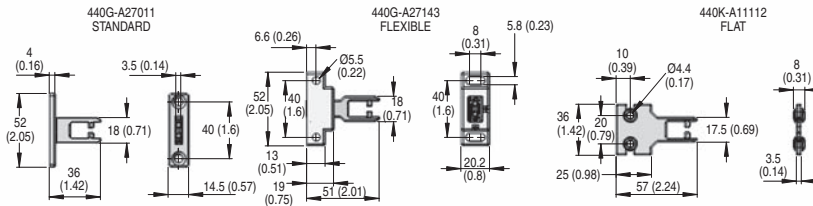
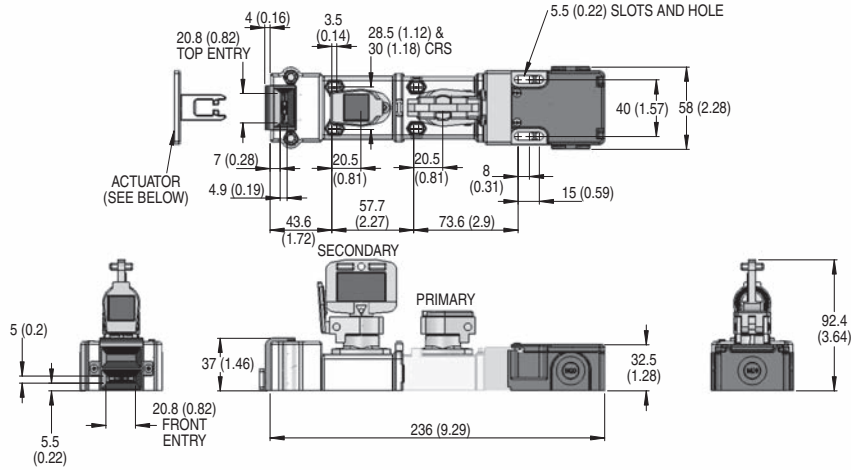

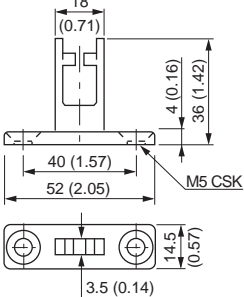

Dimensions are not intended to be used for installation purposes.

Dual Key Slamlock

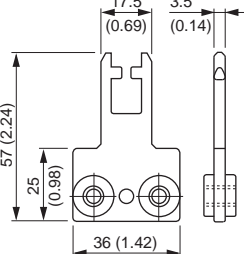

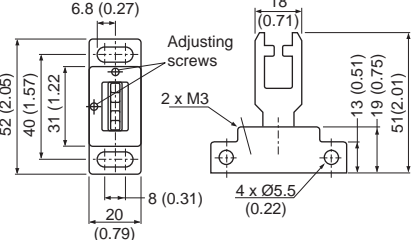
3-Trapped Key  
 Switches

Accessories

	Description	Approximate Dimensions [mm (in.)]	Cat. No.
	GD2 standard actuator		440G-A27011
	GD2 flat actuator		440K-A11112
	Fully flex actuator		440G-A27143
	Stainless steel key	page 3-140	440T-AKEYE10⊗
	Stainless steel replacement code barrel with dust cap		440T-ASCBE14*
	Stainless steel weatherproof replacement dust cap		440T-ASFC10⊗

\* Substitute the desired primary code for this symbol (key not included). See 3-107 for code selection.  
 ⊗ Substitute the desired code for this symbol. See 3-107 for code selection.

Typical Applications

Actuator out, key trapped, safety contacts open, auxiliary contact closed.

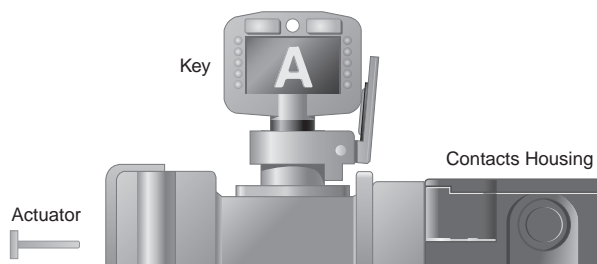

Locking force = 2000 N (450 lb)

3-Trapped Key Switches

# Safety Switches

## Miniature Valve Interlocks



### Features

- Direct drive operation
- Supplied with valves 0.25...1 in.
- Direct body mounting with security screws
- Locked open or locked closed options
- Virtually maintenance free
- Weatherproof stainless steel dust cap as standard
- Replaceable code barrel assembly
- Valve is chrome-plated brass

### Approximate Dimensions [mm (in.)]

Dimensions are not intended to be used for installation purposes.

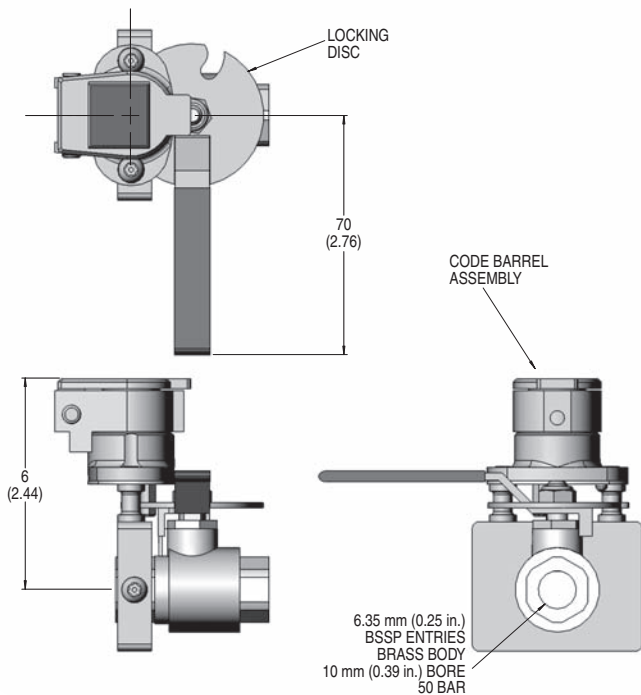

Approximate Dimensions [mm (in.)]

Model	A	B	C
440T-VMVLE10	104 (4.1)	68 (2.7)	38 (1.5)
440T-VMVLE11	104 (4.1)	68 (2.7)	38 (1.5)
440T-VMVLE12	112 (4.4)	80 (3.2)	48 (1.9)
440T-VMVLE13	104 (4.1)	68 (2.7)	38 (1.5)
440T-VMVLE14	104 (4.1)	68 (2.7)	38 (1.5)
440T-VMVLE15	112 (4.4)	80 (3.2)	48 (1.9)
440T-VMVLE16	108 (4.3)	110 (4.3)	53 (2.1)
440T-VMVLE17	108 (4.3)	110 (4.3)	53 (2.1)
440T-VMVLE18	115 (4.5)	110 (4.3)	61 (2.4)
440T-VMVLE19	115 (4.5)	110 (4.3)	61 (2.4)

### Specifications

Standards	EN1088, ISO12100-1&2, ISO14119, AS4024.1
Certifications	CE Marked for all applicable directives and BG
Operating Temperature [C (F)]	-10...+40 ° (14...104 °)
Mechanical Life	100,000 operations
Shear Force to Key	15.1 k•N (3398 lbs)
Torque to Key	14 N•m (124 lb•in)
Relative Humidity	25...95%
Material	316L stainless steel

### Product Selection

Valve Size	Valve Status	Cat. No.
0.25 in. BSP*	Key Free/Valve Locked Closed	440T-VMVLE10*
0.375 in. BSP*		440T-VMVLE11*
0.5 in. BSP*		440T-VMVLE12*
0.25 in. BSP*	Key Free/Valve Locked Open	440T-VMVLE13*
0.375 in. BSP*		440T-VMVLE14*
0.5 in. BSP*		440T-VMVLE15*
1.0 in. BSP*	Key Free/Valve Locked Closed	440T-VMVLE18*
	Key Free/Valve Locked Open	440T-VMVLE19*
2.0 in. BSP*	Key Free/Valve Locked Closed	440T-VMVLE20*
	Key Free/Valve Locked Open	440T-VMVLE21*

\* Substitute the desired primary code for this symbol (key not included). See 3-107 for code selection.

\* BSP = British standard pipe threads.

### Accessories

Description	Additional Information	Cat. No.
Stainless steel key	3-140	440T-AKEYE10*
Stainless steel replacement code barrel with dust cap		440T-ASCBE14*
Stainless steel weatherproof replacement dust cap		440T-ASFC10*

\* Substitute the desired primary code for this symbol (key not included). See 3-107 for code selection.



## Description

The switch gear adaptor is used to interlock preparatory switch gear applications or other host equipment such as spool valves. Power is isolated and locked off when the key is rotated and removed. The key can then be used in the next sequence of operation.

## Features

- Virtually maintenance free

## Specifications

Standards	EN1088, ISO12100-1&2, ISO14119, AS4024.1
Category	Cat. 1 per EN 954-1
Certifications	CE Marked for all applicable directives and BG
Operating Temperature [C (F)]	-10...+50 ° (14...122 °)
Mechanical Life	>100,000 operations
Shear Force to Key	15.1 k•N (3398 lbs), max.
Torque to Key	14 N•m (124 lb•in), max.
Relative Humidity	95%
Weight [kg (lbs)]	0.30 (0.66)
Material	316L stainless steel
Mounting	2 x M4
Shaft Dimensions	3/8 in <sup>2</sup> x 7/8 in long (standard) 9/16 in dia. x 7/8 in long (optional: contact factory)

## Product Selection (3/8 square shaft)

Mounting	Trap Direction	Cat. No.
2 x M4	65° CW to trap	440T-MSGAU10*
	65° CCW to trap	440T-MSGAU11*
	90° CW to trap	440T-MSGAU12*
	90° CCW to trap	440T-MSGAU13*
	±90° to trap	440T-MSGAU14*
	45° CW to trap	440T-MSGAU17*
	45° CCW to trap	440T-MSGAU18*

\* Substitute the desired primary code for this symbol (key not included). See 3-107 for code selection.

## Accessories

Description	Additional Information	Cat. No.
Stainless steel key	3-140	440T-AKEYE10*
Stainless steel ejector key		440T-AKEYE13*
Stainless steel weatherproof replacement dust cap		440T-ASFC10*

\* Substitute the desired primary code for this symbol (key not included). See 3-107 for code selection.

## Approximate Dimensions [mm (in.)]

Dimensions are not intended to be used for installation purposes.

### 45° Mounting Type

#### Panel Drilling Detail

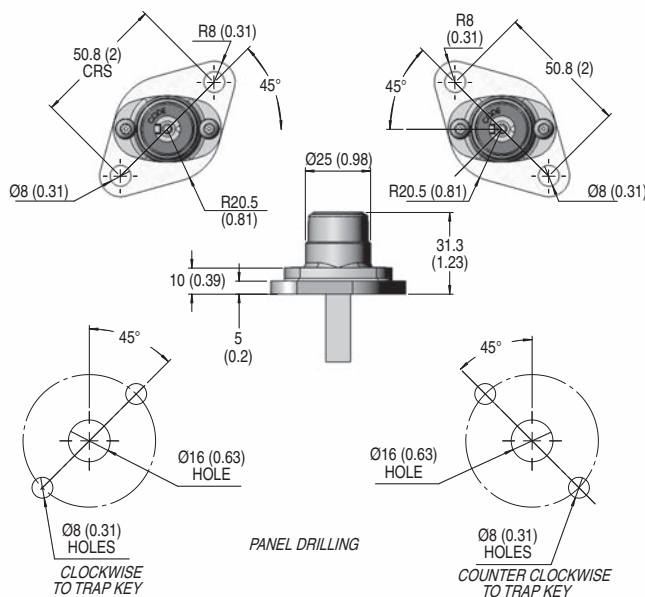





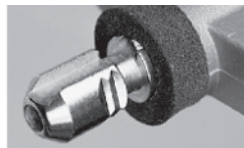



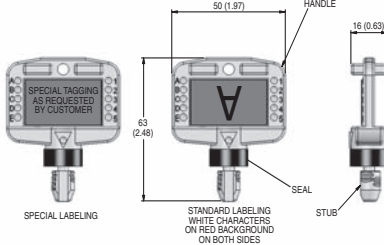

3-Trapped Key  
Switches

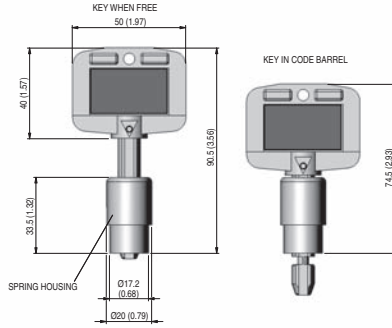
## The Prosafe Advantage

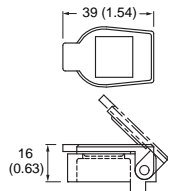

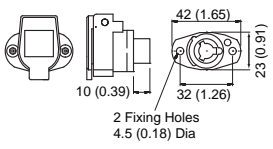
Stainless steel construction.

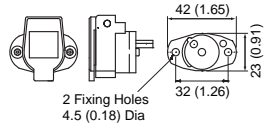
Accessories

	Description	Approximate Dimensions [mm (in.)]	Cat. No.
	Stainless steel key		440T-AKEYE10*
	Stainless steel ejector key		440T-AKEYE13*
	Stainless steel weatherproof replacement dust cap		440T-ASFC10*
	Stainless steel replacement code barrel for 100 A unit rotary switch		440T-ASCBE11*
	Stainless steel replacement code barrel with dust cap*		440T-ASCBE14*
	Description	Material	Cat. No.
	Emergency break glass key box	Plastic case	440T-AIPB11
		Metal case with hammer	440T-AIPB12
	Description	Code	Cat. No.
	Emergency repair kit for code barrels* 2 offset pin code barrels with key	ER1 ER2 ER3 ER4 ER5 ER6 ER7 ER8 ER9	440T-AKITE45ER1 440T-AKITE45ER2 440T-AKITE45ER3 440T-AKITE45ER4 440T-AKITE45ER5 440T-AKITE45ER6 440T-AKITE45ER7 440T-AKITE45ER8 440T-AKITE45ER9

\* Substitute the desired primary code for this symbol (key not included). See 3-107 for code selection.

\* Not suitable for 440T-MRKSE14/440T-MRPSE14 OR 440T-MSGAU units.



**WARNING:** The presence of spare keys, override keys, or spare actuators can compromise the integrity of safety interlocking systems. Personal injury or death, property damage or economic loss can result from the introduction of spare keys, override keys or spare actuators into interlocking systems without appropriate management controls, working procedures and alternative protective measures to control their use and availability.

3-Trapped Key Switches





22 mm Small Plastic



22 mm Compact Metal



30 mm Large Metal



15 mm Plastic

### General Description

The 440P limit switch family offers a full range of international-style solutions for both safety and standard sensing applications. Available in four different body styles—30 mm metal, 22 mm metal and plastic, and 15 mm plastic—with a broad selection of operator types, circuit arrangements and connection options, the 440P is ideal for a wide variety of applications. These include material handling, packaging, elevators, escalators, scissor lifts, industrial trucks and tractors, cranes and hoists, overhead door as well as general safety guarding applications.

### Mechanical Enclosure

The large metal-body (440P-M) models feature die-cast alloy construction and conform to EN 50041 (30 x 60 mm), while the small plastic (440P-C) models are constructed of a glass-filled polymer and conform to EN 50047 (22 mm). Both body types are IP66 rated and available with M20 or 1/2 in. NPT conduit opening or in a micro quick-disconnect version. The 15 mm plastic models (440P-M18001 and 440P-M18002) are constructed of glass-filled polyester and are IP30 rated. The 22 mm metal models (440P-A) have a painted body and are IP66/IP67 rated.

### Actuator Type

The 440P international-style limit switches are available with a wide variety of actuators to solve a broad range of applications. All lever-type switches include their respective actuator arm. The large, metal-body style is available in the following operator types:

- Metal roller plunger
- Metal dome plunger
- Metal short lever

The compact metal body style is available in the following operator types:

- Roller plunger
- Dome plunger
- Short lever
- Cross roller plunger

All, except the short lever, are available with panel mount threading.

The small, plastic-body style is available in the following operator types:

- Short lever
- Hinge lever
- Roller plunger
- Dome plunger
- Offset hinge lever

The 15 mm plastic switch is available with top push roller and top push cross roller actuators.

### Contact Arrangements

All 440P international-style limit switches contain positive opening-action contacts, making them ideal for safety-related applications. The small, plastic models include a choice of snap-acting, slow-break/make with 2- or 3-contact configurations, while the large-metal switches contain snap-acting, slow-break contacts in 2-, 3-, or 4-contact configurations. The 15 mm plastic versions are slow-break, 2-circuit models. The small metal models are all snap-acting, 2-circuit.

Safety Switches  
**IEC Style Switches**  
 22 mm Compact Metal Position Switches



**Description**

The 22 mm IEC style metal safety limit switches have been developed to provide a small metal case with a choice of actuator heads. All units are supplied with an integral 2 m cable. For safety applications it is important that upon actuation, the guard or other moving objects should not pass completely over the switch and allow the plunger or lever to return to its original position.

**Features**

- Rugged die cast enclosure
- Positive operation, forced disconnection of contacts (direct opening action)
- Snap-acting contact actuation
- Contacts 1 N.C. + 1 N.O.
- Pre-wired 2 m cable, bottom or side exit

**Specifications**

Safety Ratings	
Standards	EN 954-1, ISO 13849-1, IEC/EN 60204-1, NFPA 79, EN 1088, ISO 14119, IEC/EN 60947-5-1, ANSI B11.19, AS 4024.1
Safety Classification	Cat. 1 Device per EN 954-1 Dual channel limit switch suitable for Cat. 3 or 4 systems when ganged together
Certifications	UL Recognized, TÜV and CE Marked for all applicable directives

Outputs	
Safety Contacts *	1 N.C. snap acting
Auxiliary Contacts	1 N.O. snap acting
Thermal Current	10 A
Rated Insulation Voltage	300V AC

**Contact Rating**

Maximum AC Contact Rating Per Pole						
NEMA Rating	Max. Voltage	Amperes		Continuous Carrying Current (Amp.)	Volt Amperes	
		Make	Break		Make	Break
AC15/B300	120	30	3.0	5	3600	360
AC15/B300	240	15	1.5			

Maximum DC Contact Rating Per Pole						
DC13/Q300	240	0.27	0.27	2.5	69	69

Operating Characteristics	
Actuation Speed, Max.	250 mm/s
Actuation Speed, Min.	100 mm/min
Actuation Frequency, Max.	6000 operations per hr
Mechanical Life	1 x 10 <sup>7</sup>

Environmental	
Enclosure Type Rating	NEMA 1, IP66/67
Operating Temperature [C (F)]	2...70 ° (35.6...158 °)
Pollution Degree	3

Physical Characteristics	
Housing Material	Die-cast alloy
Actuator Material	Various polymers and metals
Mounting	2 x M14, any position
Vibration	IEC 68-2-6 (10...55 Hz, 0.35 mm amplitude)
Shock	IEC 68-2-7 (30 Gn 3 pulses per axis)
Connection Type	2 m (6.5 ft) cable
Color	Red body/black head

\* The safety contacts are described as normally closed (N.C.) i.e., with the guard closed, actuator in place (where relevant) and the machine able to be started.

3-Limit Switches

**Product Selection**

Operator Type	Contact			Typical Force/Torque to Operate	Panel Mount	Contact Opening Characteristics <input type="checkbox"/> Open <input checked="" type="checkbox"/> Closed ⊕ Positive Opening Point	Cat. No.		
	Safety	Auxiliary	Type				Bottom Cable Style	Side Cable Style	
Roller Plunger	1 N.C.	1 N.O.	Snap Acting	10 (2.25)	No		<b>440P-ARPS11C</b>	<b>440P-ARPS11CS</b>	
					Yes		440P-ARP1S11C	440P-ARP1S11CS	
Dome Plunger	1 N.C.	1 N.O.	Snap Acting	10 (2.25)	No		440P-ADPS11C	440P-ADPS11CS	
					Yes		440P-ADP1S11C	440P-ADP1S11CS	
Cross Roller Plunger	1 N.C.	1 N.O.	Snap Acting	10 (2.25)	No		440P-ACRS11C	440P-ACRS11CS	
					Yes		440P-ACR1S11C	440P-ACR1S11CS	
Lever	1 N.C.	1 N.O.	Snap Acting	0.7 N•m (0.62 lb•in)	—			<b>440P-ASLS11C</b>	<b>440P-ASLS11CS</b>

**Approximate Dimensions [mm (in.)]**

Dimensions are not intended to be used for installation purposes.

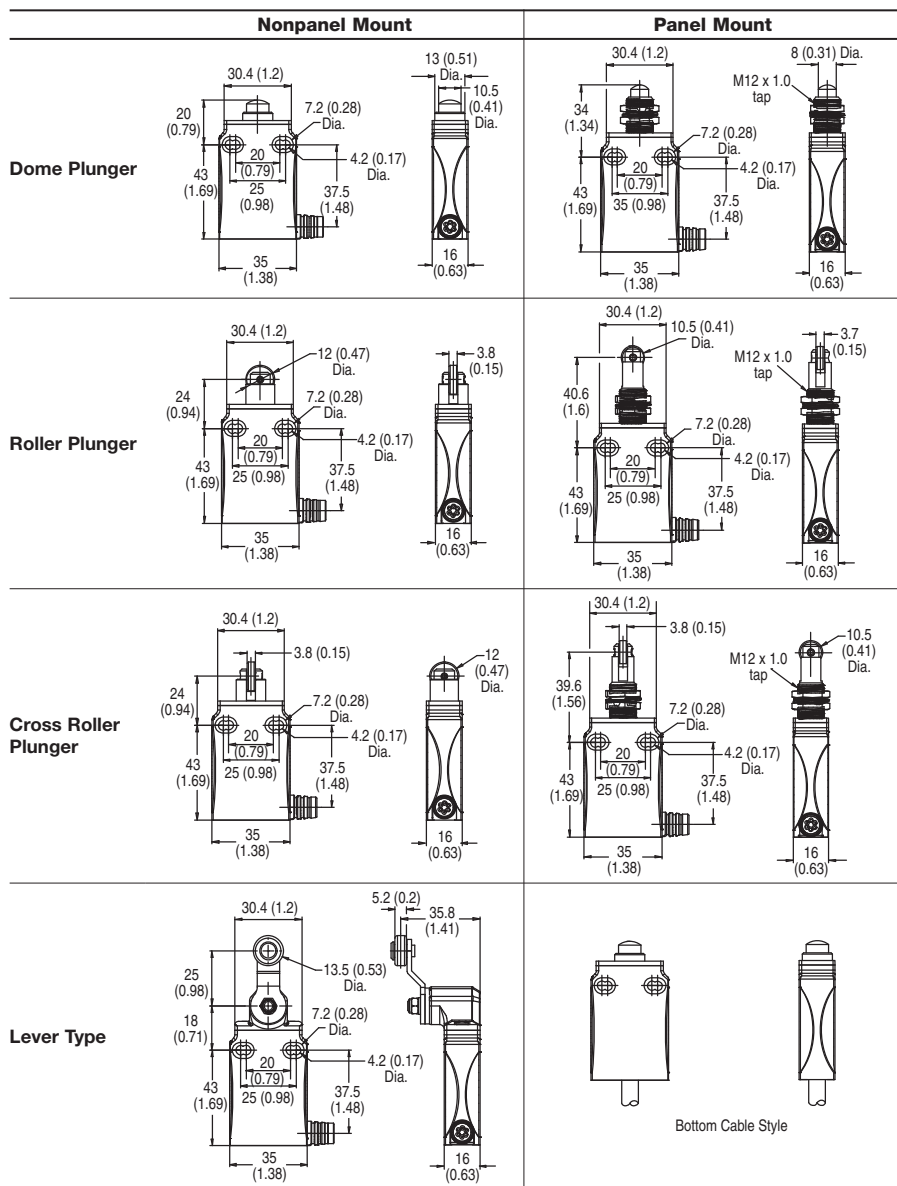

- Side cable style shows strain relief only. Units include a 2 m integral cable.
- Bottom cable style units have same dimensions as side cable style.
- Panel mount clearance hole = 13 mm (0.51 in.)

**Countersink Hole**

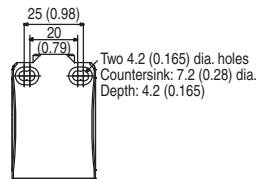

**Typical Wiring Diagrams**

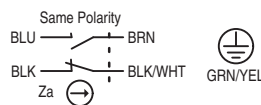

**3-Limit Switches**

# Safety Switches

## IEC Style Switches

### 22 mm Plastic Body



### Description

These 22 mm plastic-body safety limit switches conform to EN 50047 standards and are available with snap-acting or slow-break/make 2- or 3-contact configurations as well as a variety of actuator heads.

These switches also feature an optional rotating head that can be adjusted in 90° increments before installation to allow for ease of mounting.

Allen-Bradley Guardmaster limit switches can be used in guard door applications as well as on moving machine beds, crane arms, lifts, elevators, etc.

Operation of these limit switches is achieved by the sliding action of a guard, or other moving object, deflecting the plunger or lever. For safety applications, it is important that upon actuation, the guard or moving object should not pass completely beyond the switch to allow the plunger or lever to return to its original position—the plunger or lever must remain engaged by the guard or object.

### Features

- Large selection of actuator heads
- Positive operation, forced disconnection of contacts
- Snap-acting, slow make before break or slow break before make contact blocks
- Contacts 1 N.C. + 1 N.O., 2 N.C. + 1 N.O. 3 N.C.
- Conforms to EN 50047, EN 1088, EN 60947-5-1, EN 292 and EN 60204-1

### Operating Examples

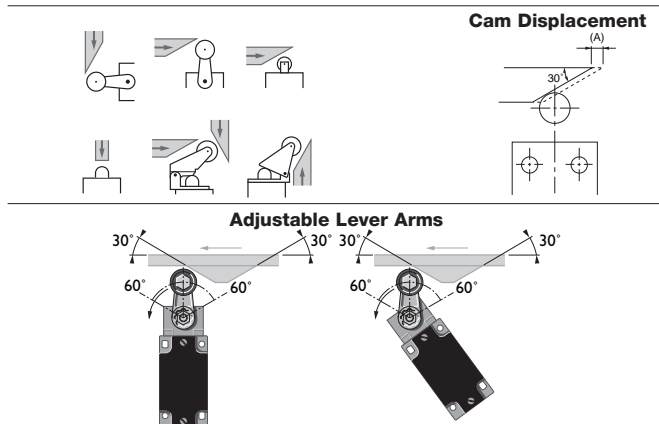

The actuating cam should be profiled at 30° for optimum operation.

**Note:** Plunger-type switches operate from a flat profile.

### Specifications







Safety Ratings	
Standards	EN 954-1, ISO 13849-1, IEC/EN 60204-1, NFPA 79, EN 1088, ISO 14119, IEC/EN 60947-5-1, ANSI B11.19, AS 4024.1
Safety Classification	Cat. 1 Device per EN 954-1 Dual channel limit switch suitable for Cat. 3 or 4 systems and used with a safety monitoring device
Functional Safety Data *	B10d: > 2 x 10 <sup>6</sup> operations at min. load PFH <sub>D</sub> : > 3 x 10 <sup>-7</sup> MTTF <sub>D</sub> : > 385 years Dual channel limit switch may be suitable for performance levels Pl <sub>e</sub> or Pl <sub>d</sub> (according to ISO 13849-1:2006) and for use in SIL2 or SIL3 systems (according to IEC 62061) depending on application characteristics
Certifications	CE Marked for all applicable directives, cULus, and TÜV
Outputs	
Safety Contacts *	1 N.C. snap acting, 2 N.C. or 3 N.C. slow acting
Auxiliary Contacts	1 N.O. (except 3 N.C. versions)
Thermal Current/ <i>I<sub>th</sub></i>	10 A
Rated Insulation Voltage	600V AC
Switching Current @ Voltage, Min.	25 mA @ 5V DC
Utilization Category	
A600/AC-15	(Ue) 600V 500V 240V 120V (Ie) 1.2 A 1.4 A 3.0 A 6.0 A
N600/DC-13	(Ue) 600V 500V 250V 125V (Ie) 0.4 A 0.55 A 1.1 A 2.2 A
Operating Characteristics	
Actuation Speed, Max.	250 mm/s
Actuation Speed, Min.	100 mm/min
Actuation Frequency, Max.	6000 operation per hour
Mechanical Life	1 x 10 <sup>7</sup>
Environmental	
Enclosure Type Rating	IP66
Operating Temperature [C (F)]	-25...80° (-18...+176°)
Pollution Degree	3
Physical Characteristics	
Housing Material	UL Approved glass-filled polybutylene terephthalate
Actuator Material	Various polymers and metals
Mounting	2 x M4, Any position
Vibration	IEC 68-2-6 (10...55 Hz, 0.35 mm amplitude)
Shock	IEC 68-2-7 (30 Gn 3 pulses per axis)
Conduit Entry	M20 or 1/2 inch NPT
Color	Red

\* Usable for ISO 13849-1:2006 and IEC 62061. Data other than B10d is based on:

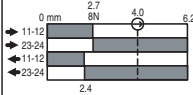
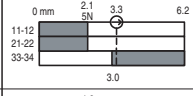
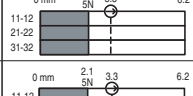
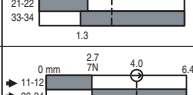
- Usage rate of 1op/10 mins., 24 hrs/day, 360 days/year, representing 51840 operations per year
- Mission time/Proof test interval of 38 years

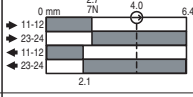
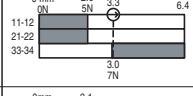
\* The safety contacts are described as normally closed (N.C.) i.e., with the guard closed, actuator in place (where relevant) and the machine able to be started.

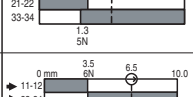
**Product Selection**

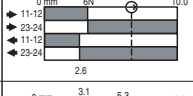
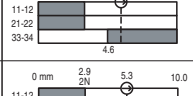
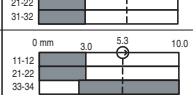
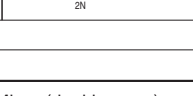



Description	Contact			Typical Force/Torque to Operate	Contact Opening Characteristics	Cat. No.		
	Safety	Auxiliary	Type		<input type="checkbox"/> Open <input checked="" type="checkbox"/> Closed ⊕ Positive Opening Point	1/2 inch NPT Conduit	M20 Conduit	Connector Style*
	1 N.C.	1 N.O.	Snap acting	5 N		<b>440P-CRPS11E</b>	440P-CRPS11B	440P-CRPS11D4
	2 N.C.	1 N.O.	BBM	6 N		440P-CRPB12E	440P-CRPB12B	440P-CRPB12R6
	3 N.C.	—	—	5 N		440P-CRPB03E	440P-CRPB03B	440P-CRPB03R6
Roller Plunger	2 N.C.	1 N.O.	MBB	6 N		440P-CRPM12E	440P-CRPM12B	440P-CRPM12R6
	1 N.C.	1 N.O.	Snap acting	5N		<b>440P-CDPS11E</b>	440P-CDPS11B	440P-CDPS11D4
	2 N.C.	1 N.O.	BBM	6N		440P-CDPB12E	440P-CDPB12B	440P-CDPB12R6
	3 N.C.	—	—	5N		440P-CDPB03E	440P-CDPB03B	440P-CDPB03R6
Dome Plunger	2 N.C.	1 N.O.	MBB	6N		440P-CDPM12E	440P-CDPM12B	440P-CDPM12R6
	1 N.C.	1 N.O.	Snap Acting	5N		<b>440P-CHLS11E</b>	440P-CHLS11B	440P-CHLS11D4
	2 N.C.	1 N.O.	BBM	6N		<b>440P-CHLB12E</b>	440P-CHLB12B	440P-CHLB12R6
	3 N.C.	—	—	5N		440P-CHLB03E	440P-CHLB03B	440P-CHLB03R6
	Hinge Lever	2 N.C.	1 N.O.	MBB	6N		440P-CHLM12E	440P-CHLM12B
Recommended standard cordset, 2 m, 4-pin, DC Micro (M12) connector.								889D-F4AC-2
Recommended standard cordset, 2 m, 6-pin, AC Micro (M12) connector.								889R-F6ECA-2

\* D4 suffix uses a 4-pin DC Micro (M12) connector and R6 suffix uses a 6-pin AC Micro (dual keyway) consumer.

3-Limit Switches

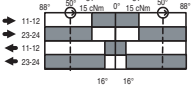
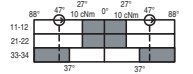
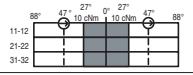
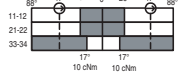
Safety Switches  
**IEC Style Switches**  
 22 mm Plastic Body

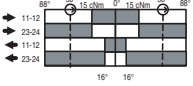
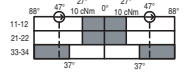
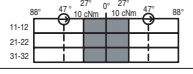
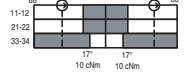
Product Selection (continued)

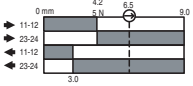
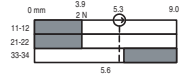
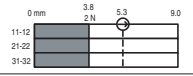
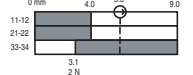
Description	Contact			Typical Force/Torque to Operate	Contact Opening Characteristics	Cat. No.		
	Safety	Auxiliary	Type		<input type="checkbox"/> Open <input checked="" type="checkbox"/> Closed ⊕ Positive Opening Point	1/2 inch NPT Conduit	M20 Conduit	Connector Style*
	1 N.C.	1 N.O.	Snap acting	0.15 N•m		440P-CSLS11E	440P-CSLS11B	440P-CSLS11D4
	2 N.C.	1 N.O.	BBM	0.14 N•m		440P-CSLB12E	440P-CSLB12B	440P-CSLB12R6
	3 N.C.	—	—	0.14 N•m		440P-CSLB03E	440P-CSLB03B	440P-CSLB03R6
	2 N.C.	1 N.O.	MBB	0.14 N•m		440P-CSLM12E	440P-CSLM12B	440P-CSLM12R6
	1 N.C.	1 N.O.	Snap acting	0.15 N•m		440P-CMHS11E	440P-CMHS11B	440P-CMHS11D4
	2 N.C.	1 N.O.	BBM	0.14 N•m		440P-CMHB12E	440P-CMHB12B	440P-CMHB12R6
	3 N.C.	—	—	0.14 N•m		440P-CMHB03E	440P-CMHB03B	440P-CMHB03R6
	2 N.C.	1 N.O.	MBB	0.14 N•m		440P-CMHM12E	440P-CMHM12B	440P-CMHM12R6
	1 N.C.	1 N.O.	Snap acting	5 N		440P-COHS11E	440P-COHS11B	440P-COHS11D4
	2 N.C.	1 N.O.	BBM	6 N		440P-COHB12E	440P-COHB12B	440P-COHB12R6
	3 N.C.	—	—	5 N		440P-COHB03E	440P-COHB03B	440P-COHB03R6
	2 N.C.	1 N.O.	MBB	6 N		440P-COHM12E	440P-COHM12B	440P-COHM12R6
Recommended standard cordset, 2 m, 4-pin, DC Micro (M12) connector.								889D-F4AC-2
Recommended standard cordset, 2 m, 6-pin, AC Micro (M12) connector.								889R-F6ACA-2

\* D4 suffix uses a 4-pin DC Micro (M12) connector and R6 suffix uses a 6-pin AC Micro (dual keyway) consumer.

3-Limit Switches

Typical Wiring Diagrams \*

Two-Circuit Type D4 4-Pin Micro Connector

Connector Pinout		1 N.C. + 1 N.O.	
		Terminal	Contact
<p>Same Polarity 1 N.O. + 1 N.C.</p>		1	11
		3	12
		2	23
		4	24
			N.C.
			N.O.

Three-Circuit Type R6 6-Pin Micro Connector

Connector Pinout		3 N.C.		2 N.C. + 1 N.O.	
		Terminal	Contact	Terminal	Contact
<p>3 N.C.      2 N.C. + 1 N.O.</p>		1	11	11	N.C.
		5	12	12	N.C.
		2	21	21	N.C.
		6	22	22	N.C.
		3	33	31	N.C.
		4	34	32	N.C.

\* See page 3-145 for positive opening circuits.

Approximate Dimensions [mm (in.)]

Dimensions are not intended to be used for installation purposes.

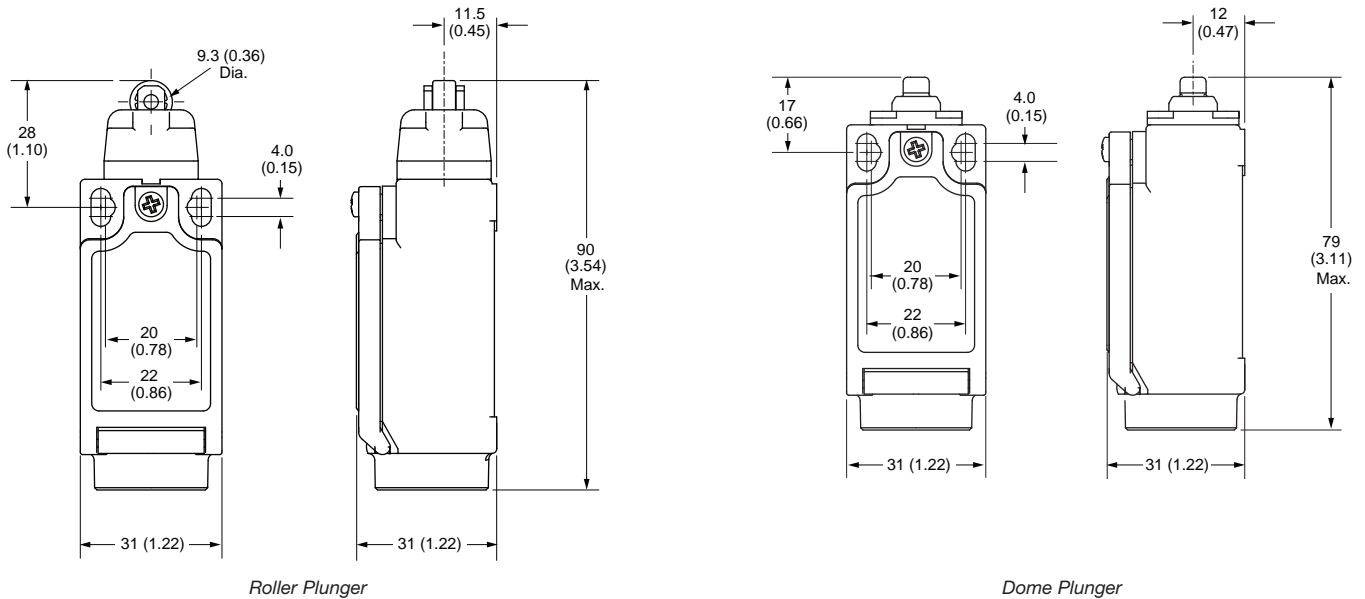

3-Limit  
Switches

Safety Switches  
**IEC Style Switches**  
 22 mm Plastic Body

Approximate Dimensions [mm (in.)] (continued)

Dimensions are not intended to be used for installation purposes.

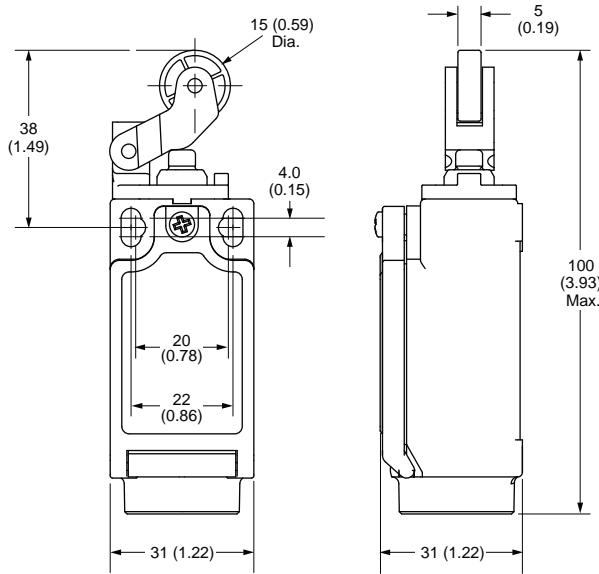

Hinge Lever

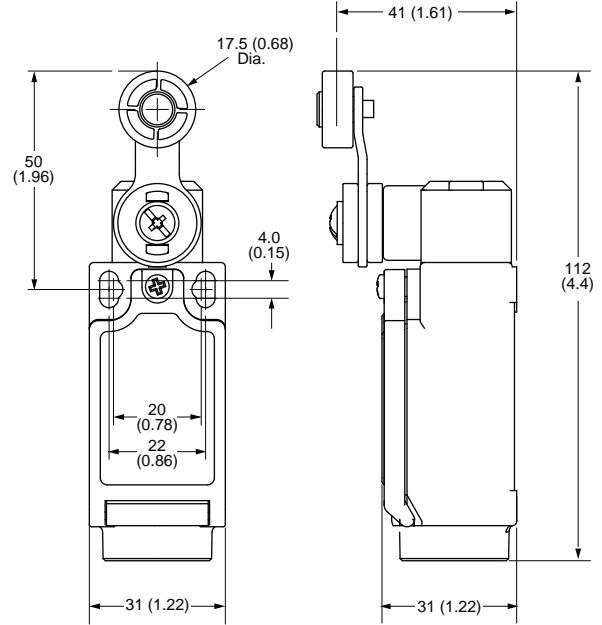

Short Lever,  
 Metal and Plastic Roller

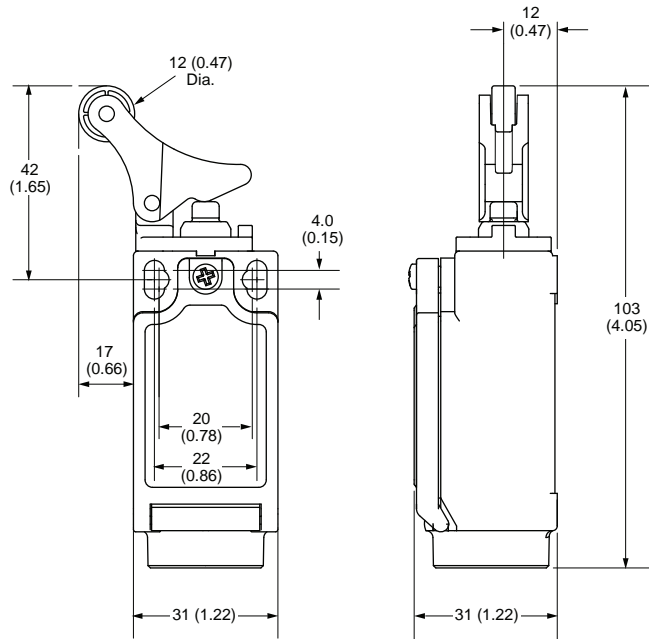

Offset Hinge

3-Limit  
 Switches





### Description

These 30 mm metal-body safety limit switches conform to EN 50041 standards and are available in snap acting or slow break/make with 2-, 3- or 4-contact configurations.

These switches feature a rotating head that can be adjusted in 90° increments before installation to allow for ease of mounting.

Allen-Bradley Guardmaster can be used in guard door applications as well as on moving machine beds, crane arms, lifts, elevators, etc.

Operation of these limit switches is achieved by the sliding action of a guard, or other moving object, deflecting the plunger or lever. For safety applications, it is important that upon actuation, the guard or moving object should not pass completely beyond the switch to allow the plunger or lever to return to its original position—the plunger or lever must remain engaged by the guard or object.

### Features

- Large selection of actuator heads
- Positive operation, forced disconnection of contacts
- Snap-acting, slow make before break or slow break before make contact blocks
- Contacts 1 N.C. + 1 N.O., 2 N.C. + 2 N.O., 3 N.C. + 1 N.O., or 4 N.C.
- Conforms to EN 50041, EN 1088, EN 60947-5-1, EN 292 and EN 60204-1

### Operating Examples

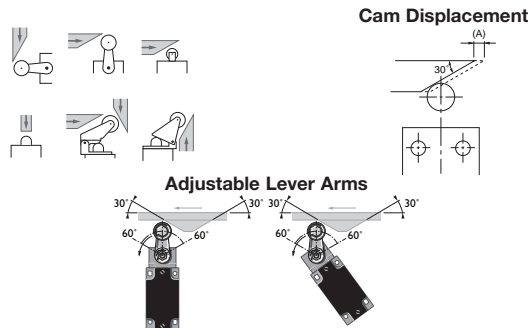

For optimum cam operation, the actuating arm should be adjusted with a 30° offset profile.

**Note:** Plunger-type switches operate from a flat profile.

### Specifications





Safety Ratings					
Standards	EN 954-1, ISO 13849-1, IEC/EN 60204-1, NFPA 79, EN 1088, ISO 14119, IEC/EN 60947-5-1, ANSI B11.19, AS 4024.1				
Safety Classification	Cat. 1 Device per EN954-1 Dual-channel limit switch suitable for Cat. 3 or 4 systems and used with a safety monitoring device				
Functional Safety Data *	B10d: > 2 x 10 <sup>6</sup> operations at min. load PFH <sub>D</sub> : > 3 x 10 <sup>-7</sup> MTTFd: > 385 years Dual channel limit switch may be suitable for performance levels Pl <sub>e</sub> or Pl <sub>d</sub> (according to ISO 13849-1:2006) and for use in SIL2 or SIL3 systems (according to IEC 62061) depending on application characteristics				
Certifications	CE Marked for all applicable directives, cULus, and TÜV				
Outputs					
Safety Contacts *	1 N.C. snap acting, 2 N.C., 3 N.C. or 4 N.C. slow acting				
Auxiliary Contacts	1 N.O., 2 N.O., or zero				
Thermal Current/ <i>I<sub>th</sub></i>	10 A				
Rated Insulation Voltage	600V AC				
Switching Current @ Voltage, Min.	25 mA @ 5V DC				
Utilization Category					
A600/AC-15	(Ue)	600V	500V	240V	120V
	(Ie)	1.2 A	1.4 A	3.0 A	6.0 A
N600/DC-13	(Ue)	600V	500V	250V	125V
	(Ie)	0.4 A	0.55 A	1.1 A	2.2 A
Operating Characteristics					
Actuation Speed, Max.	250 mm/s				
Actuation Speed, Min.	100 mm/min				
Actuation Frequency, Max.	6000 operation per hour				
Mechanical Life	1 x 10 <sup>7</sup>				
Environmental					
Enclosure Type Rating	IP66				
Operating Temperature [C (F)]	-25...80° (-18...+176°)				
Pollution Degree	3				
Physical Characteristics					
Housing Material	Die-cast alloy				
Actuator Material	Various polymers and metals				
Mounting	2 x M5, Any position				
Vibration	IEC 68-2-6 (10...55 Hz, 0.35 amplitude)				
Shock	IEC 68-2-7 (30 Gn 3 pulses per axis)				
Conduit Entry	M20 or 1/2 inch NPT				
Color	Red				

\* Usable for ISO 13849-1:2006 and IEC 62061. Data other than B10d is based on:  
 - Usage rate of 1op/10 mins., 24 hrs/day, 360 days/year, representing 51840 operations per year  
 - Mission time/Proof test interval of 38 years

\* The safety contacts are described as normally closed (N.C.) i.e., with the guard closed, actuator in place (where relevant) and the machine able to be started.

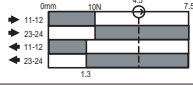
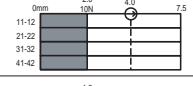
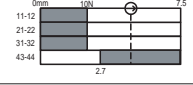
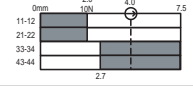
Safety Switches  
**IEC Style Switches**  
 30 mm Metal Body

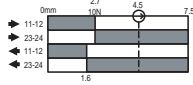
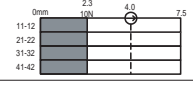
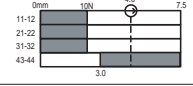
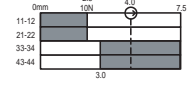

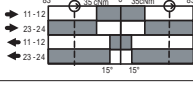
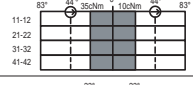
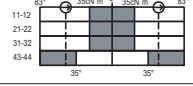
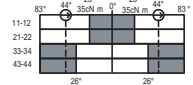
Product Selection

Description	Contact			Typical Force/Torque to Operate	Contact Opening Characteristics <input type="checkbox"/> Open <input checked="" type="checkbox"/> Closed ⊕ Positive Opening Point	Cat. No.		
	Safety	Auxiliary	Type			1/2 inch NPT Conduit	M20 Conduit	Connector *
	1 N.C.	1 N.O.	Snap Acting	13 N		440P-MRPS11E	440P-MRPS11B	440P-MRPS11N5
	4 N.C.	—	—	11 N		440P-MRPB04E	440P-MRPB04B	440P-MRPB04M9
	3 N.C.	1 N.O.	BBM	11 N		440P-MRPB13E	440P-MRPB13B	440P-MRPB13M9
	2 N.C.	2 N.O.	BBM	11 N		<b>440P-MRPB22E</b>	440P-MRPB22B	440P-MRPB22M9
	1 N.C.	1 N.O.	Snap Acting	13 N		<b>440P-MDPS11E</b>	440P-MDPS11B	440P-MDPS11N5
	4 N.C.	—	—	11 N		440P-MDPB04E	440P-MDPB04B	440P-MDPB04M9
	3 N.C.	1 N.O.	BBM	11 N		440P-MDPB13E	440P-MDPB13B	440P-MDPB13M9
	2 N.C.	2 N.O.	BBM	11 N		440P-MDPB22E	440P-MDPB22B	440P-MDPB22M9
	1 N.C.	1 N.O.	Snap Acting	0.34 N•m		<b>440P-MSLS11E</b>	440P-MSLS11B	440P-MSLS11N5
	4 N.C.	—	—	0.20 N•m		440P-MSLB04E	440P-MSLB04B	440P-MSLB04M9
	3 N.C.	1 N.O.	BBM	0.34 N•m		440P-MSLB13E	440P-MSLB13B	440P-MSLB13M9
	2 N.C.	2 N.O.	BBM	0.34 N•m		440P-MSLB22E	440P-MSLB22B	440P-MSLB22M9
Recommended standard cordset, 2 m, 5-pin mini connector.								889N-F5AE-6F
Recommended standard cordset, 2 m, 12-pin 9-wire.								889M-FX9AE-2

\* N5 = 5-pin mini connector.  
 M9 = 12-pin M23 connector (use 9 wire).

3-Limit Switches

Product Selection (continued)

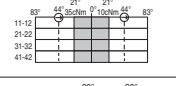
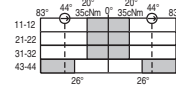
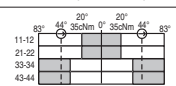
Description	Safety Contacts	Auxiliary Contacts	Contact Type	Typical Force/Torque to Operate	Contact Opening Characteristics □ Open ■ Closed ⊕ Positive Opening Point	Cat. No.		
						1/2 inch NPT Conduit	M20 Conduit	Connector *
	1 N.C.	1 N.O.	Snap Acting	0.34 N•m		440P-MMHS11E	440P-MMHS11B	440P-MMHS11N5
	4 N.C.	—	—	0.20 N•m		440P-MMHB04E	440P-MMHB04B	440P-MMHB04M9
	3 N.C.	1 N.O.	BBM	0.34 N•m		440P-MMHB13E	440P-MMHB13B	440P-MMHB13M9
	Metal Short Lever, Metal Roller	2 N.C.	2 N.O.	BBM	0.34 N•m		440P-MMHB22E	440P-MMHB22B
Recommended standard cordset, 2 m, 5-pin mini connector.								889N-F5AE-6F
Recommended standard cordset, 2 m, 12-pin 9-wire.								889M-FX9AE-2

\* N5 = 5-pin mini connector.  
 M9 = 12-pin M23 connector (use 9 wire).

Typical Wiring Diagrams

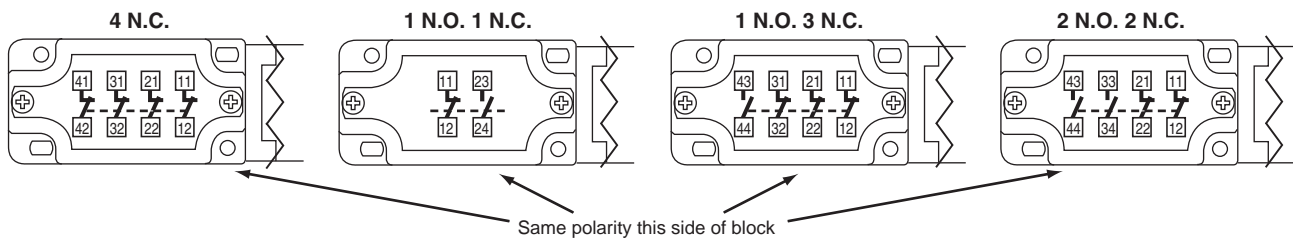

N5 Connector 2 Circuit 5-Pin Mini Connector

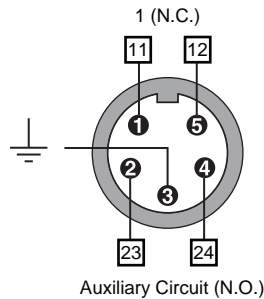

M9 12-Pin M23 Connector

Connector Pinout	4 N.C.		3 N.C. 1 N.O.		3 N.C.	
	Terminal	Contact	Terminal	Contact	Terminal	Contact
1	11		11		11	
3	12	N.C.	12	N.C.	12	N.C.
4	21		21		21	
6	22	N.C.	22	N.C.	22	N.C.
7	31		31		33	N.O.
8	32	N.C.	32	N.C.	34	N.O.
9	41		43	N.O.	43	N.O.
10	42	N.C.	44		44	
12				Ground		

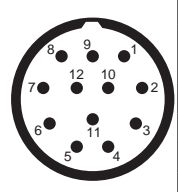

3-Limit Switches

Safety Switches  
**IEC Style Switches**  
 30 mm Metal Body

**Approximate Dimensions [mm (in.)]**

*Dimensions are not intended to be used for installation purposes.*

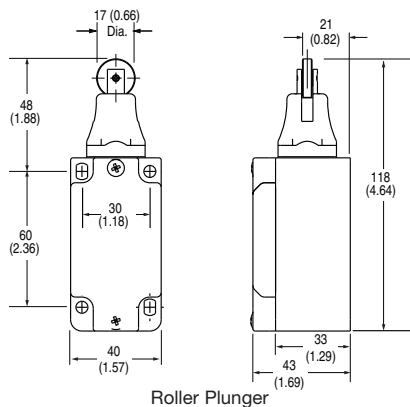

Roller Plunger

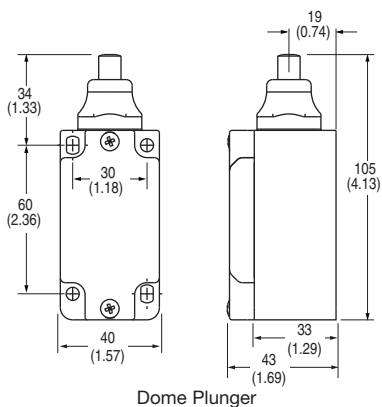

Dome Plunger

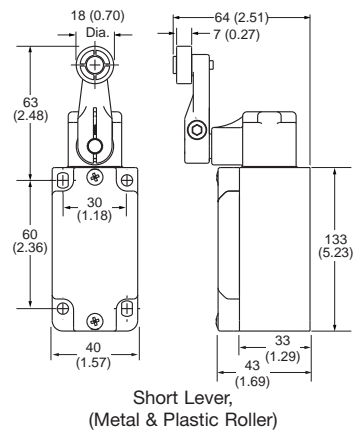

Short Lever,  
 (Metal & Plastic Roller)

3-Limit  
Switches



Imp 1



Imp 2

### Description

The Imp offers safety switch performance of bigger units in the most compact case available. Designed with two mounting hole options and a choice of actuator positions, the Imp will fit in most confined spaces.

### Features

- Positive operation, forced disconnection of contacts
- Contacts 1 N.C. + 1 N.O.

### Specifications

Safety Ratings	
Standards	EN 954-1, ISO 13849-1, IEC/EN 60204-1, NFPA 79, EN 1088, ISO 14119, IEC/ EN 60947-5-1, ANSI B11.19, AS 4024.1
Safety Classification	Cat. 1 Device per EN954-1 Dual channel limit switch suitable for Cat. 3 or 4 systems
Functional Safety Data *	B10d: > 2 x 10 <sup>6</sup> operations at min. load PFH <sub>D</sub> : > 3 x 10 <sup>-7</sup> MTTFd: > 385 years Dual channel limit switch may be suitable for performance levels Pl <sub>e</sub> or Pl <sub>d</sub> (according to ISO 13849-1:2006) and for use in SIL2 or SIL3 systems (according to IEC 62061) depending on application characteristics
Note:	For up-to-date information, visit <a href="http://www.ab.com/Safety/">http://www.ab.com/Safety/</a>
Certifications	CE Marked for all applicable directives and CSA NRTL/C
Outputs	
Safety Contacts *	1 N.C. positive break
Auxiliary Contacts	1 N.O.
Thermal Current/ <i>I<sub>th</sub></i>	10 A (I <sub>th</sub> )
Rated Insulation Voltage	(U <sub>i</sub> ) 500V
Switching Current @ Voltage, Min.	25 mA @ 5V DC
Utilization Category	
AC-15	(U <sub>e</sub> ) 500V    250V    100V (I <sub>e</sub> ) 1 A        2 A        5 A
DC	(U <sub>e</sub> ) 250V    24V (I <sub>e</sub> ) 0.5 A    2 A
Operating Characteristics	
Actuation Speed, Max.	160 mm (6.29 in.)/s
Actuation Speed, Min.	100 mm (3.93 in.)/min
Actuator Travel, Max.	5 mm (0.20 in.)
Actuation Frequency, Max.	2 cycles/s
Mechanical Life	10,000,000 operations
Electrical Life	1,000,000 operations
Mechanical Life	10,000,000 operations
Environmental	
Enclosure Type Rating	IP30
Operating Temperature [C (F)]	-25...80° (-13...176°)
Pollution Degree	3
Physical Characteristics	
Housing Material	UL Approved glass-filled PBT
Actuator Material	Stainless steel
Mounting	2 x M4 front or 2 x M3 top
Vibration	10...55 Hz
Shock	11 ms @ 30 g
Conduit Entry	3x break-outs
Color	Red

\* Usable for ISO 13849-1:2006 and IEC 62061. Data other than B10d is based on:

- Usage rate of 1op/10 mins., 24 hrs/day, 360 days/year, representing 51840 operations per year
- Mission time/Proof test interval of 38 years

\* The safety contacts are described as normally closed (N.C.) i.e., with the guard closed, actuator in place (where relevant) and the machine able to be started.

Safety Switches  
**IEC Style Switches**  
 15 mm Plastic Body

Product Selection

Actuator Type	Contact		Contact Action	Conduit	Type	Cat. No.
			<input type="checkbox"/> Open <input checked="" type="checkbox"/> Closed ⊕ Positive Opening Point			
Top push roller	Slow break before make	1 N.C. & 1 N.O.		3 x breakouts	Imp 1 (roller parallel to switch front)	440P-M18001
Top push cross roller					Imp 2 (roller perpendicular to switch front)	440P-M18002

Approximate Dimensions [mm (in.)]

Dimensions are not intended to be used for installation purposes.

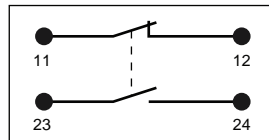
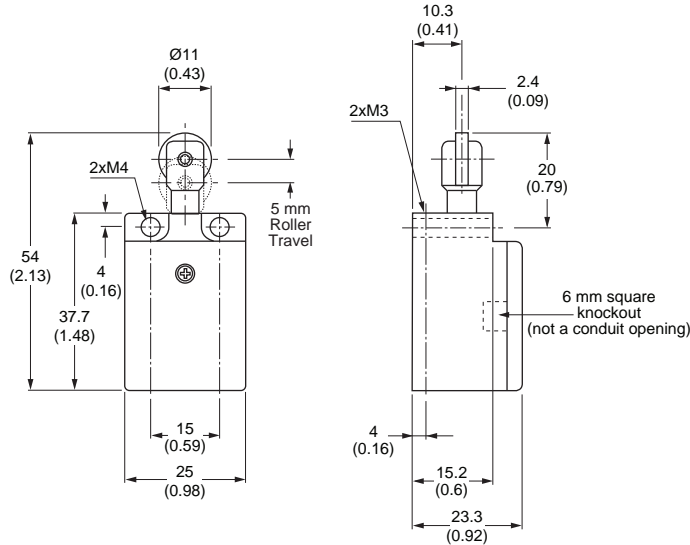

3-Limit  
Switches

Wiring Diagrams



### Description

The 802T Direct Opening Action limit switches have been designed for use in control reliable applications and safety applications per ISO 14119. These limit switches utilize the same mounting dimensions as other NEMA style limit switches. The rugged metal construction and plug-in body are designed for use in harsh industrial environments.

Direct Opening Action allows the normally closed contacts to open when the limit switch is actuated. This opening will occur even in the event of a contact weld condition, up to 10 Newtons.



**ATTENTION:** To ensure that the normally closed (safety) contacts open, the limit switch actuator must be displaced beyond the point of Direct Opening Action (see specifications).

### Features

- Direct opening action
- Snap acting contacts
- Rugged metal construction
- Long life and reliability
- Plug-in design
- NEMA 12, 13, 4, 6P/IP67 sealing

### Typical Applications

- Machine guards
- Access gates and doors
- Cranes or hoists
- Transfer stations
- Indexing tables
- Robotic cells

### Specifications

Safety Ratings	
Standards	EN 954-1, ISO 13849-1, IEC/EN 60204-1, NFPA 79, EN 1088, ISO 14119, IEC/EN 60947-5-1, ANSI B11.19, AS 4024.1
Safety Classification	Cat. 1 Device per EN 954-1 Dual channel limit switch suitable for Cat. 3 or 4 systems
Functional Safety Data * <b>Note:</b> For up-to-date information, visit <a href="http://www.ab.com/Safety/">http://www.ab.com/Safety/</a>	B10d = > 2 x 10 <sup>6</sup> operations at min. load PFH <sub>D</sub> = > 3 x 10 <sup>-7</sup> MTTF <sub>D</sub> = > 385 years Dual channel limit switch may be suitable for Performance levels Ple or Pld (according to ISO 13849-1:2006) and for use in SIL2 or SIL3 systems (according to IEC 62061) depending on application characteristics
Certifications	CE Marked for all applicable directives, cULus Listed, and TÜV for 2- and 4-circuit models

Outputs	
Safety Contacts *	1 N.C. snap acting or 2 N.C. snap acting
Auxiliary Contacts	1 N.O. snap acting or 2 N.O. snap acting
Thermal Current/ <i>I<sub>th</sub></i>	10 A
Rated Insulation Voltage	300V AC or 600V AC
Switching Current @ Voltage, Min.	—

Utilization Category					
A600/AC-15	(Ue)	600V	500V	240V	120V
	(Ie)	1.2 A	1.4 A	3.0 A	6.0 A
N600/DC-13	(Ue)	600V	500V	250V	125V
	(Ie)	0.4 A	0.55 A	1.1 A	2.2 A

Operating Characteristics	
Actuation Speed, Max.	200 ft/min varies with applied loading and actuation method*
Actuation Speed, Min.	200 ft/min varies with applied loading and actuation method*
Actuation Frequency, Max.	8000 operations per hour
Mechanical Life	20 million cycles

Environmental	
Enclosure Type Rating	NEMA 4, 6P, 12, 13 and IP65/67
Operating Temperature [C (F)]	-18...+110° (0...+230°)
Pollution Degree	3

Physical Characteristics	
Housing Material	Die-cast alloy
Actuator Material	Various metals or plastics
Mounting	2 #10 equal length fasteners
Vibration	Contact fragility (10...2000 Hz @ 0.06 inch peak-to-peak)
Shock	Contact fragility (25 Gn 3 pulses per axis)
Conduit Entry	1/2 inch NPT or M20
Color	Grey

\* Usable for ISO 13849-1:2006 and IEC 62061. Data other than B10d is based on:

- Usage rate of 1op/10 mins., 24 hrs/day, 360 days/year, representing 51840 operations per year
- Mission time/Proof test interval of 38 years

\* The safety contacts are described as normally closed (N.C.) i.e., with the guard closed, actuator in place (where relevant) and the machine able to be started.

**NEMA Style Switches****802T Direct Opening Action****AC Contact Rating (Maximum per Pole, 50 or 60Hz,  
2 Circuits)**

NEMA Rating Designation	Max Voltage	A		Continuous Carrying Current	VA	
		Make	Break		Make	Break
A600	120	60	6.00	10	7200	720
	240	30	3.00	10	7200	720
AC-15	480	15	1.50	10	7200	720
	600	12	1.20	10	7200	720

**AC Contact Rating (Maximum per Pole, 50 or 60Hz,  
4 Circuits)**

NEMA Rating Designation	Max Voltage	A		Continuous Carrying Current	VA	
		Make	Break		Make	Break
A300	120	60	6.00	10	7200	720
	240	30	3.00	10	7200	720

**DC Contact Rating (Maximum per Pole)**

NEMA Rating Designation	Max Voltage	A		Continuous Carrying Current	VA	
		Make	Break		Make	Break
Q300	250	0.27	0.27	2.5	69	69
	125	0.55	0.55	2.5	69	69
DC 13						

**Low Voltage DC**

24V DC @ 1.1 Amps resistive load



**Range of Operation**

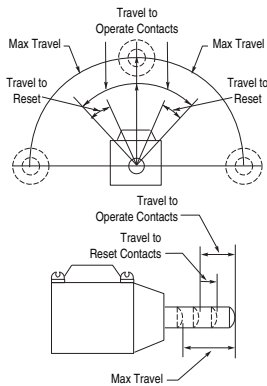

**Lever Type  
Spring Return**



**Top Push Roller  
Spring Return**



**Side Push  
Vertical Roller  
Spring Return**



**Side Push  
Horizontal Roller  
Spring Return**

**Product Selection**

Number of Circuits	Lever Movement	Description	Typical Force/Torque to Operate	Travel to Operate Contacts [mm (in.)]	Torque/Force to Operate Direct Opening Action	Travel to Operate Direct Opening Action [mm (in.)]	Maximum Travel [mm (in.)]	Travel to Reset Contacts [mm (in.)]	Cat. No.
<b>Lever Type • Spring Return</b>									
2	Clockwise or Counter Clockwise		0.45 N•m (4.0 lb•in), max.	13°, max.	0.90 N•m (8 lb•in), min.	25°, min.	90°	7°, max.	Switch w/o Lever 802T-APD
4									802T-ATPD
<b>Top Push Roller • Spring Return</b>									
2	Normal	Operated	28.47 N•m (6.4 lb•in), max.	1.17 (0.046), max.	66.72 N (15.0 lb), min.	2.29 (0.090), min.	5.99 (0.236)	0.64 (0.025), max.	Complete Switch 802T-DPD
	4								802T-DTPD
<b>Side Push Vertical Roller • Spring Return</b>									
2	Normal	Operated	24.5 N•m (5.5 lb•in), max.	2.08 (0.082), max.	53.4 N (12.0 lb), min.	4.19 (0.165), min.	5.74 (0.226)	1.14 (0.045), max.	Complete Switch 802T-KPD
	4								802T-KTPD
<b>Side Push Horizontal Roller • Spring Return</b>									
2	Normal	Operated	24.5 N•m (5.5 lb•in), max.	2.08 (0.082), max.	53.4 N (12.0 lb), min.	4.19 (0.165), min.	5.74 (0.226)	1.14 (0.045), max.	Complete Switch 802T-K1PD
4		802T-K1TPD							

3-Limit Switches

Modifications and Typical Levers—page 3-159.

Safety Switches  
**NEMA Style Switches**  
 802T Direct Opening Action

Typical Example of a Dual Channel Safety Application

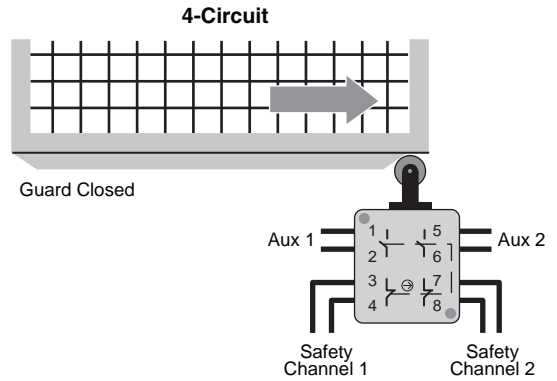
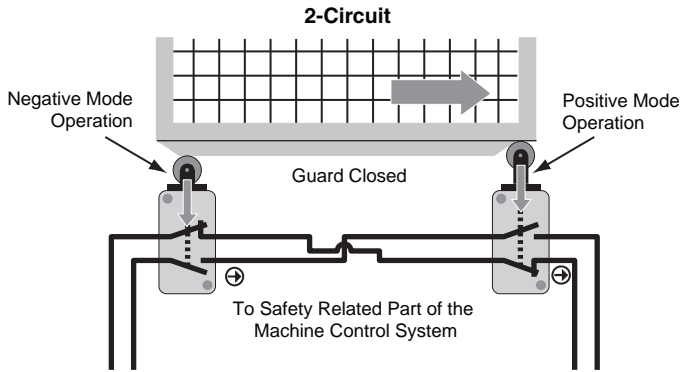

Approximate Dimensions [mm (in.)]

Dimensions are not intended to be used for installation purposes.

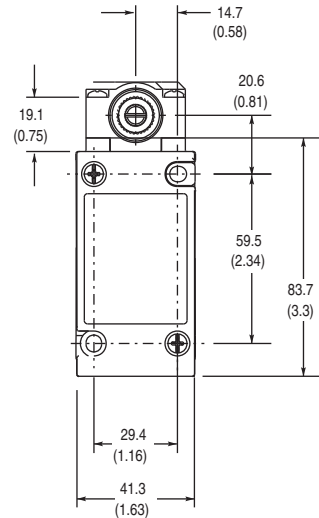
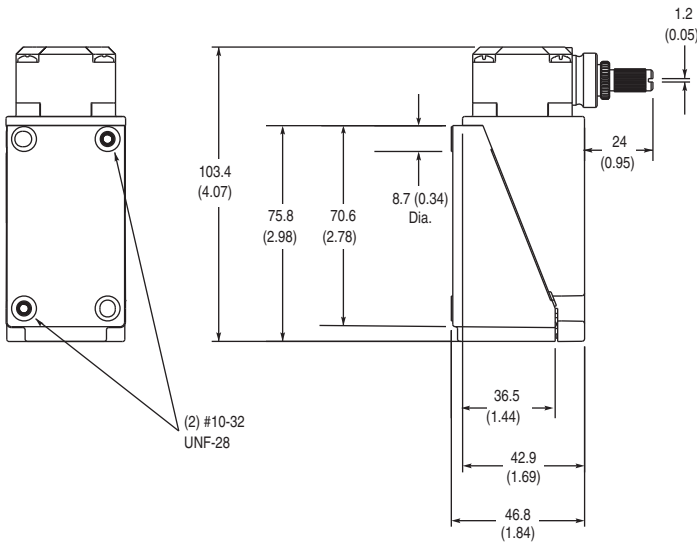

3-Limit  
Switches

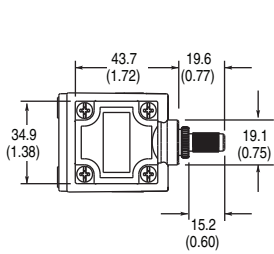

Lever Type Head

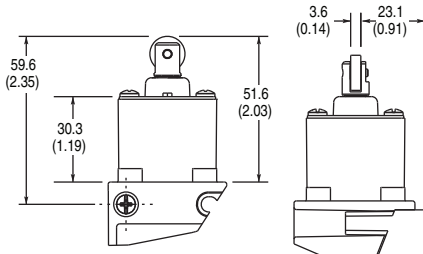

Top Push Roller Head

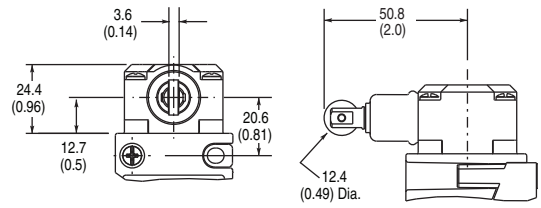

Plug-In Switch

Side Push Roller Head

**Modifications**

**Metric Conduit Entry**

To order a limit switch with a 20 mm conduit entry, add the suffix **S6** to the cat. no. **Example: 802T-APDS6.**

**Pre-wired Cable**

To order a factory-installed pre-wired type ST00W-A cable (5-conductor), add the suffix **Y** plus the number of feet required. The standard cable length is 1.52 m (5 ft). Extended cable lengths are available in multiples of 1.22 m (4 ft) only.

**Example:** To order a limit switch with a factory-installed 1.52 m (5 ft) cable, the cat. no. would become **802T-APDY5.** To order a limit switch with a factory-installed 2.44 m (8 ft) cable, the cat. no. would become **802T-APDY8.**

**Mini-Style Quick-Disconnect**

To order an 802T pre-wired limit switch with a 5-pin (2 circuit) or 9-pin (4 circuit) mini connector, add the suffix **J1** or **J9** depending on desired wiring (J9 wiring not available for 4-circuit models) to the cat. no. **Example: 802TAPDJ1.**

**5-Pin Mini-Type Receptacle (2 circuit)**

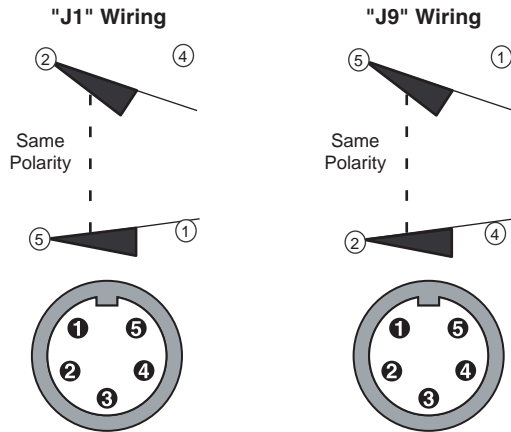

**9-Pin Mini-Type Receptacle (4 circuit)**

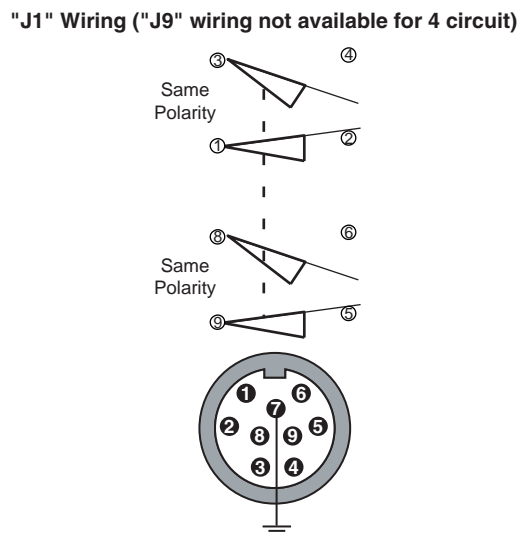

**Micro-Style Quick-Disconnect**

Micro quick-disconnects are available with a 5-pin 2-keyway AC or 5-pin single keyway DC. To order a limit switch with a AC micro quick-disconnect, add the suffix **R5** to the cat. no. To order a limit switch with a DC micro quick-disconnect, add the suffix **D5** to the cat. no. **Example: 802TAPDR5** and **802TAPDD5.**

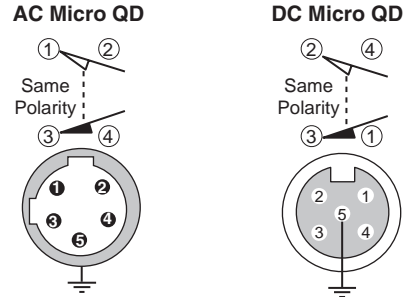

**Levers**

Type	Roller [mm (in.)]			Cat. No.
	Material	Diameter	Width	
	Nylon	19.05 (0.75)	7.11 (0.28)	802T-W1
	Nylon	19.05 (0.75)	25.4 (1.0)	802T-W1H
	Steel	19.05 (0.75)	6.35 (0.25)	802T-W1A
	Ball Bearing	19.05 (0.75)	5.84 (0.23)	802T-W1B

**Note:** Additional lever options are available in the Limit Switch section of the Sensors catalog.

3-Limit  
Switches